

TAPEPRO

DRYWALL TOOLS

FFBH-600, 900, 1050, 1200,
1500, 1800

Flat Finishing Box Handle

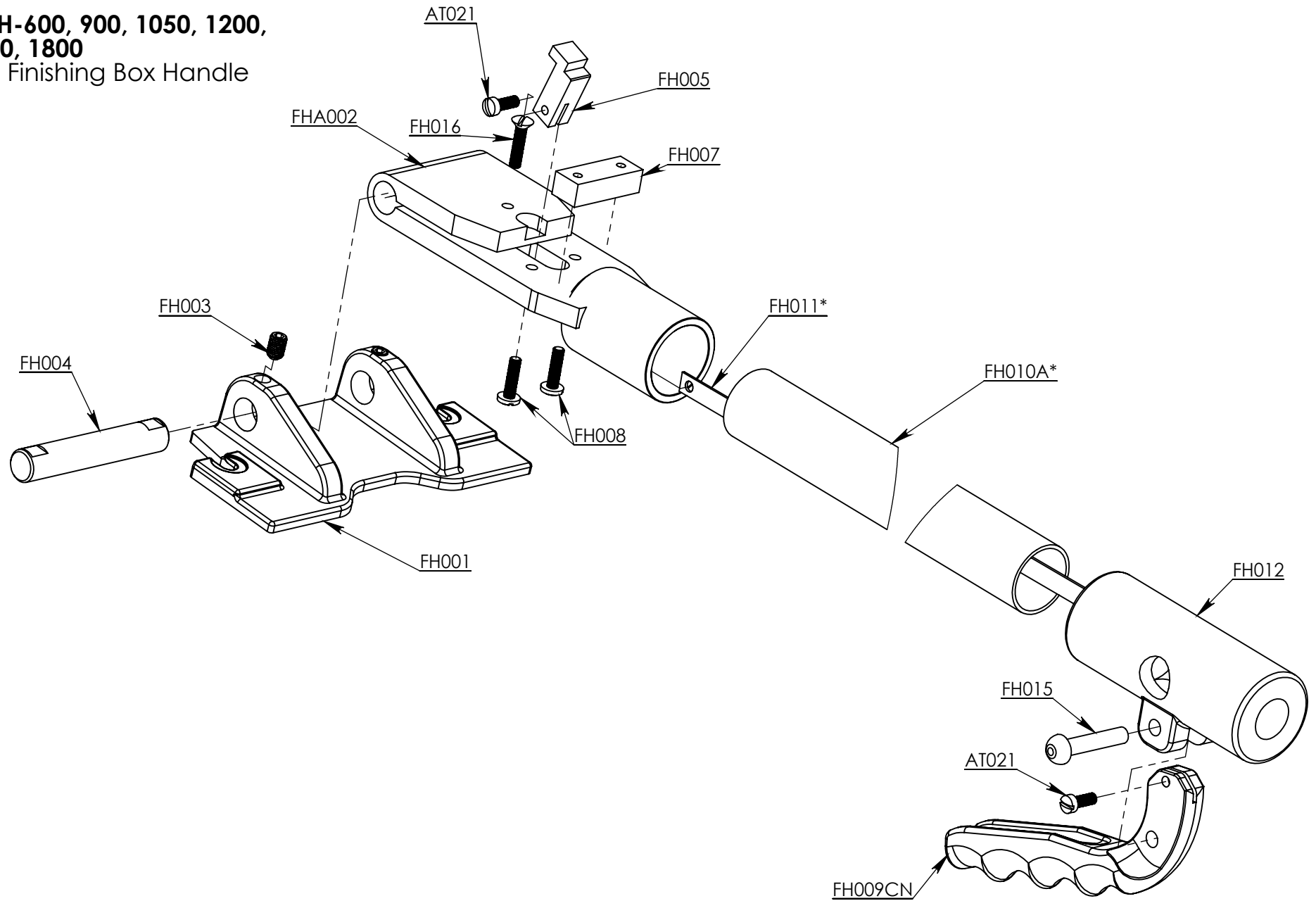

*Specify 600mm, 900mm, 1050mm, 1200mm, 1500mm or 1800mm lengths when ordering

Effective and Revised 2010